

# Model 7000 Installation Instructions

Web: [www.LCDmonitorarms.com.au](http://www.LCDmonitorarms.com.au) | Ph: 1300 798 050

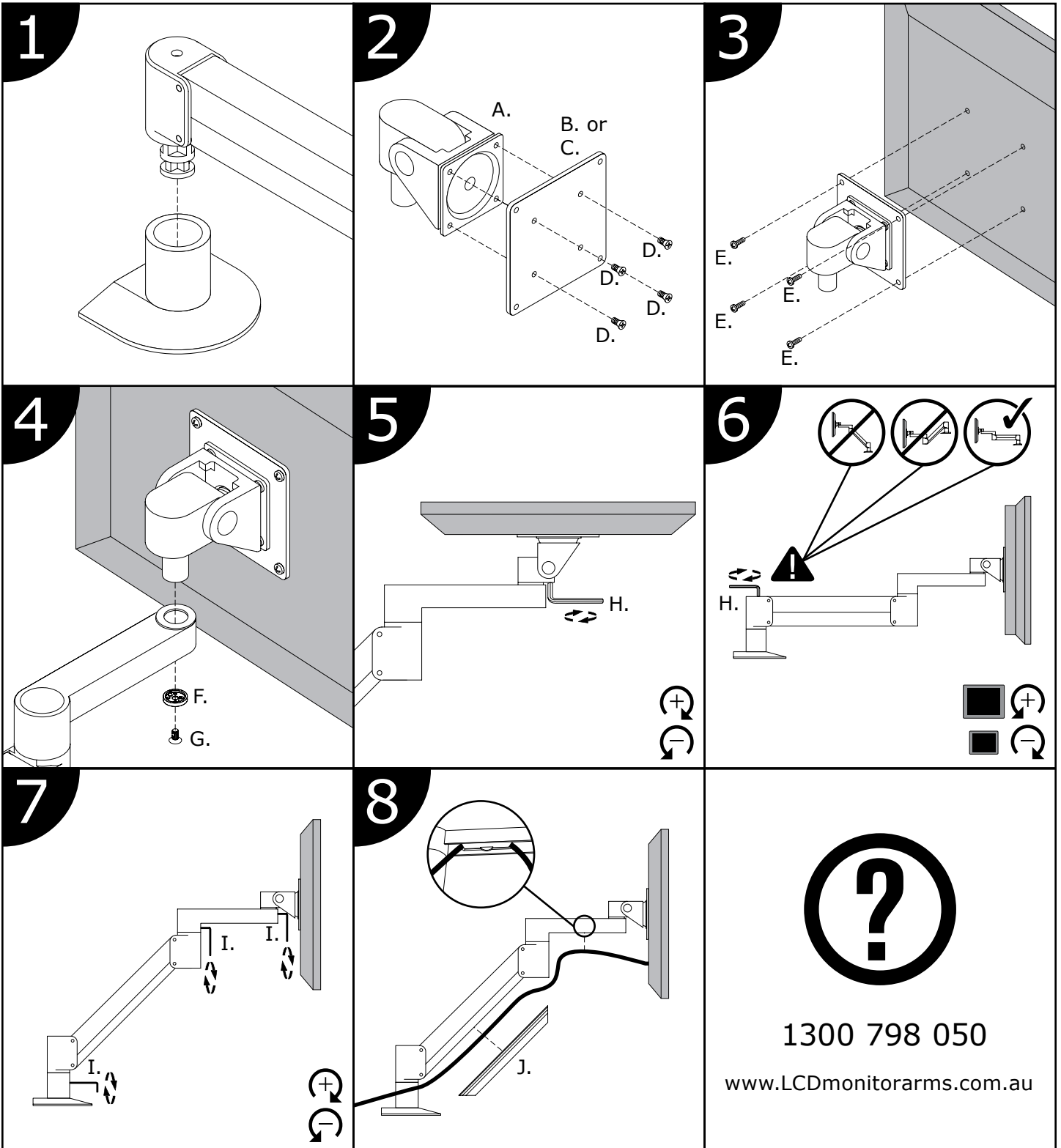





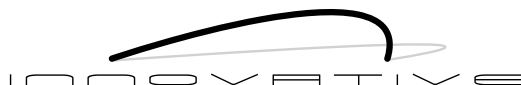

1300 798 050

[www.LCDmonitorarms.com.au](http://www.LCDmonitorarms.com.au)

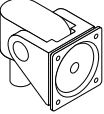
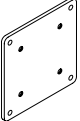
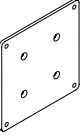

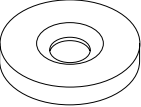
# Model 7000 Parts List

Web: [www.LCDmonitorarms.com.au](http://www.LCDmonitorarms.com.au) | Ph: 1300 798 050

ITEM	DESCRIPTION / PART NO.	QUANTITY
A. 	Monitor Tilter 8013	1
B. 	75mm VESA Adapter Plate 7VESA75	1
C. 	100mm VESA Adapter Plate 7VESA100	1
D. 	10-32 x 3/8" (9.525mm) Philips Flat Head Screw 701164	4
E. 	M4-12 Philips Pan Head Screw 702096	4
F. 	Dog Washer 105189	1
G. 	10-32 x 3/8" (9.525mm) Screw with Lock Patch 705198	1
H. 	7/32" (5.563mm) Allen Wrench 701127	1
I. 	3/32" (2.388mm) Allen Wrench 700146	1
J. 	Cable Cap 102043-9.5A	1