

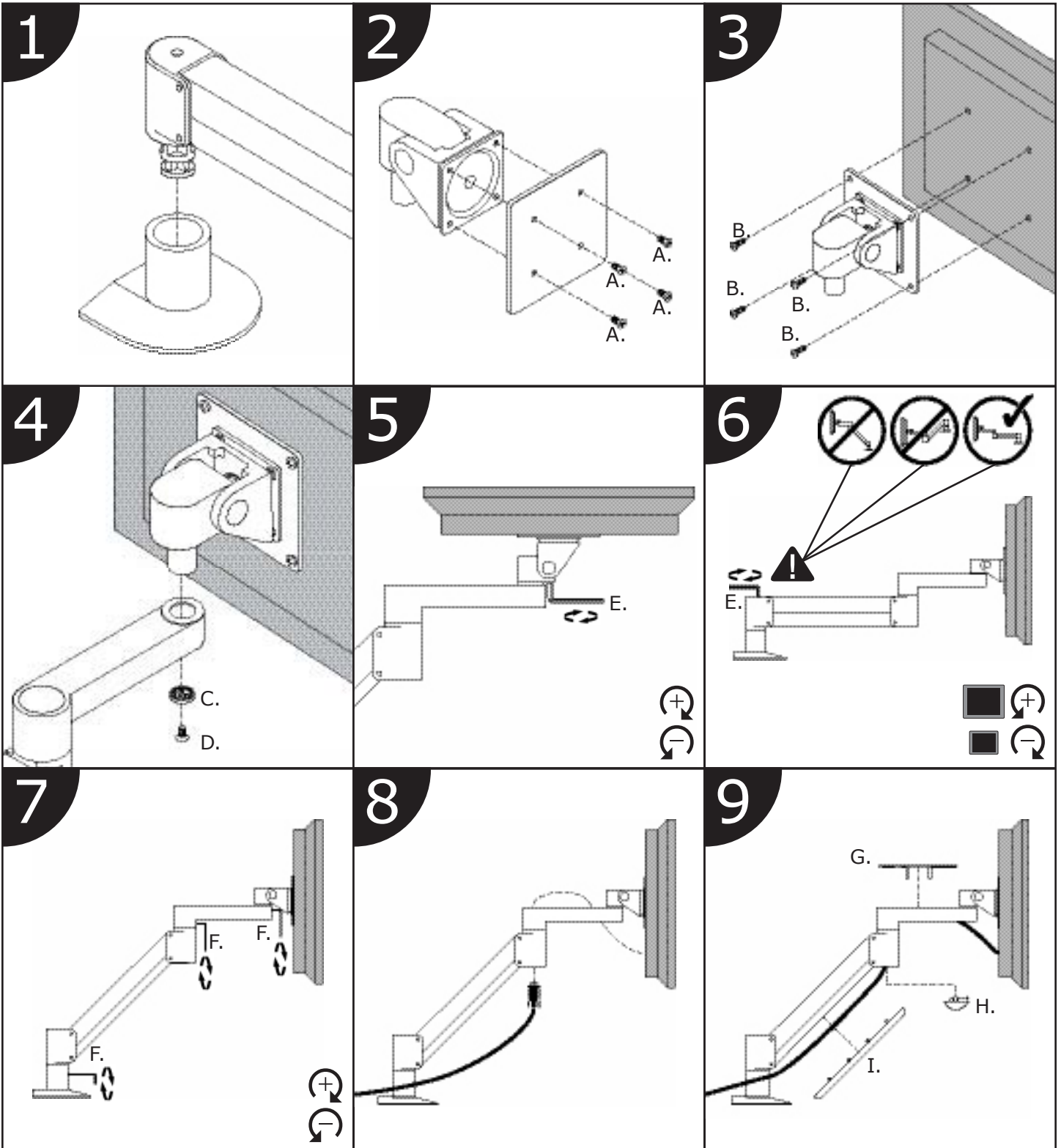









Model 7500 Installation Instructions

Web: www.LCDmonitorarms.com.au | Ph: 1300 798 050



Model 7500 Parts List

Web: www.LCDmonitorarms.com.au | Ph: 1300 798 050

ITEM	DESCRIPTION / PART NO.	QUANTITY
A. 	10-32 x 3/8" (9.525mm) Philips Flat Head Screw 701164	4
B. 	M4-12 Philips Pan Head Screw 702096	4
C. 	Dog Washer 105189	1
D. 	10-32 x 3/8" (9.525mm) Screw with Lock Patch 705198	1
E. 	7/32" (5.563mm) Allen Wrench 701127	1
F. 	3/32" (2.388mm) Allen Wrench 700146	1
G. 	Forearm Cap 702825	1
H. 	Endcap Bumper 702829	1
I. 	Cable Cap 702830	1