

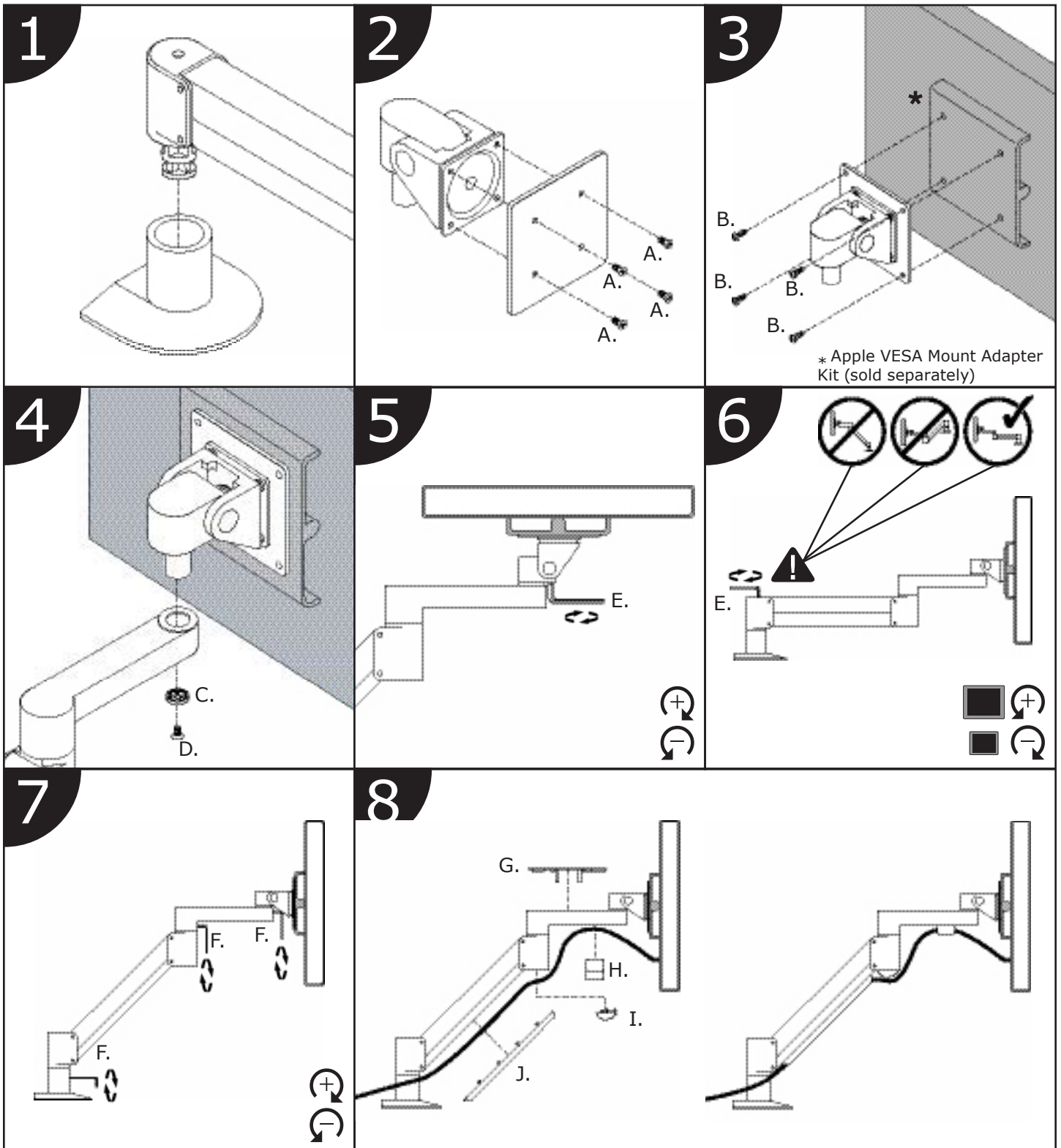







# iLift™ Installation Instructions

Web: [www.LCDmonitorarms.com.au](http://www.LCDmonitorarms.com.au) | Ph: 1300 798 050

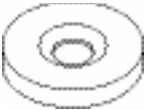

# iLift™ Parts List

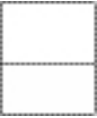
Web: [www.LCDmonitorarms.com.au](http://www.LCDmonitorarms.com.au) | Ph: 1300 798 050

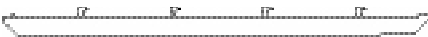
ITEM	DESCRIPTION / PART NO.	QUANTITY
A. 	<b>10-32 x 3/8" (9.525mm) Philips Flat Head Screw</b> 701164	4
B. 	<b>M4-12 Philips Pan Head Screw</b> 702096	4
C. 	<b>Dog Washer</b> 105189	1
D. 	<b>10-32 x 3/8" (9.525mm) Screw with Lock Patch</b> 705198	1
E. 	<b>7/32" (5.563mm) Allen Wrench</b> 701127	1
F. 	<b>3/32" (2.388mm) Allen Wrench</b> 700146	1
G. 	<b>Forearm Cap</b> 104549	1
H. 	<b>Cable Clip</b> 104534	1
I. 	<b>Endcap Bumper</b> 104551	1
J. 	<b>Cable Cap</b> 104550	1